

# HUNTER

Anti-Masking, Self-Testing PIR Motion Detector



Installation Instructions

## 1. INTRODUCTION

The HUNTER is a sophisticated PIR that utilizes an advanced motion analysis algorithm, the latest anti-masking technology and motion simulation self-test routines.

The advanced motion analysis algorithm - **True Motion Recognition™** - provides improved distinction between true motion of a human body and any other disturbance that would cause other detectors to produce false alarms.

Masking and/or internal circuit malfunction cause trouble indications to appear: the green LED flashes and the TRB (trouble) relay drops out. At power up, a unique software routine adapts the detector to its immediate surroundings. Despite this, if an object is too close to the lens or the field of view is too narrow, the detector will respond as it does upon masking.

The HUNTER includes temperature compensation circuits - for maximum catch performance and optimum protection from false alarms. A built-in motion event verification counter can be programmed to trigger an alarm as a result of 1 or 2 consecutive motion events, depending on the detection sensitivity required.

A "TEST" (T) input permits switching the detector to the walk-test mode and back without removing the front cover. The test input polarity can be selected with a DIP switch (see Para. 3.6).

Long-term stability and high reliability are assured by a special self-adapting algorithm, that continuously compensates for environmental changes. The entire electronic circuitry is enclosed in a protective sealed module, with the sensor element practically isolated from gusts of wind and insects.

## 2. SPECIFICATIONS

### GENERAL

**Sensor Type:** Low-noise dual-element pyroelectric unit.

**Alarm Relay:** N.C. contacts with 18-ohm resistor in series; contacts rated at 0.1 A resistive / 30 VDC

**Alarm Period:** 2-3 seconds minimum

**Tamper Switch:** N.C. contacts, 50 mA resistive / 30 VDC

**TRB Relay:** N.C. contacts with 18-ohm resistor in series; contacts rated at 0.1 A resistive / 30 VDC

**True Motion Event Verification Counter:** 1 or 2 events

**Masking Detection Delay:** 30 seconds

### POWER SUPPLY

**Input Voltage:** 9 - 16 VDC

**Standby Current Drain:** 17 mA @ 12 VDC

### OPTICAL

**Lens Type:** 90° (wide angle), 34 beams in 3 detection layers.

**Coverage Area:** 15 x 15 m (50 x 50 ft).

**Adjustment:**

**Vertical:** 0° to - 12° with built-in calibrated scale.

**Horizontal:** ±7.5° by shifting the lens left or right in the front window (greater shift is possible with optional swivel brackets).

### MOUNTING

**Configurations:** Surface or corner (without swivel brackets)

**Height:** Up to 3.6 m (12 ft)

**Optional Accessories:** **BR-1:** Swivel bracket for surface mounting, adjustable 30° downward and 45° left, 45° right. **BR-2:** BR-1 with corner mounting adapter.

**BR-3:** BR-1 with ceiling mounting adapter.

### ENVIRONMENTAL

**Operating Temperatures:**

-10° to 50°C (14° to 122°F)

**Storage Temperatures:**

-20° to 60°C (-4° to 140°F)

**RFI protection:** Greater than 20 V/m up to 1000 MHz.

### PHYSICAL DATA

**Dimensions (H x W x D):**

116 x 60 x 45 mm

(4-9/16 x 2-3/8 x 1-3/4 in.)

**Weight:** 112 g (4 oz)

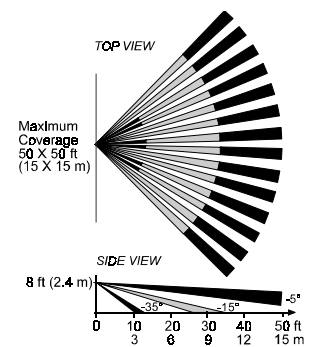

Figure 1. Coverage Pattern

## 3. INSTALLATION

### 3.1 Construction Details

The electronic circuitry is enclosed in a sealed module, attached to the base with a single screw (see Figure 2).

The electronic module may be shifted up or down along the base for vertical adjustment of the detection beam angle.

The front cover accommodates the Fresnel lens, that can be unfastened for horizontal adjustment or for replacement. The LEDs, which are positioned behind the lens, are visible when illuminated.

### 3.2 Selecting the Mounting Location

Always mount the detector unit on a firm and stable surface.

- Select the mounting location so that the expected motion of an intruder would cross the beams of the coverage pattern.
- Avoid aiming the detector at heaters, sources of bright light and windows that are subject to direct sunlight. Also avoid running the wiring close to high-power electrical cables.

- Make sure not to install the unit where obstacles are present 0.5 meter (1.5 ft) away from the lens or closer.

### 3.3 Mounting

- Remove the screw located at the bottom and then take the front cover off (see Figure 2).
- Remove the vertical adjustment screw and detach the module from the base.
- Mount the base (with the wiring entry knockouts up) in the location and height selected for optimum coverage. For surface mounting, use the two knockouts at the back of the base. For corner mounting, use the knockouts on the angled sides (see Figure 3).

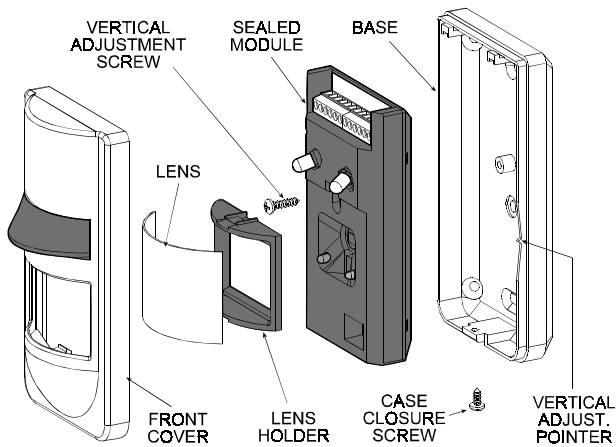

Figure 2. Exploded View of the HUNTER

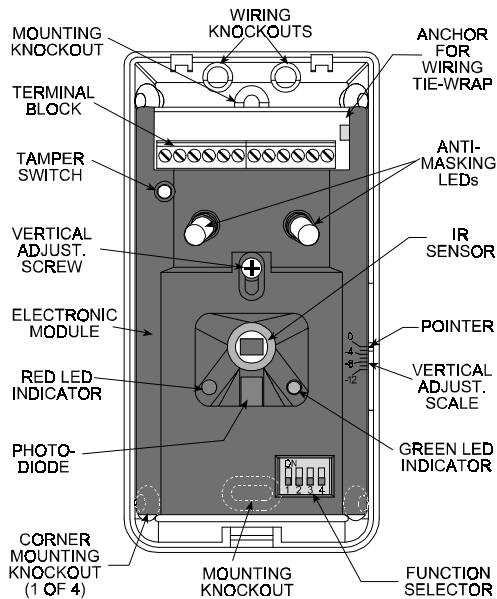

Figure 3. HUNTER as Viewed with Cover Removed

- D. Put the electronic module back in place and remount the vertical adjustment screw (but do not tighten it fully yet).
- E. Set the DIP switch function selector as required for the particular application (see Paragraph 3.6 for details).
- F. Carry out the necessary wiring operations as outlined in Paragraph 3.5).

### 3.4 Optional Swivel Brackets

Three optional swivel brackets are available. They are intended to enhance the flexibility of installation. Each bracket comes complete with detailed installation instructions in its own packing box.

**BR-1** - a surface-mounted swivel bracket (see Fig. 4).

**BR-2** - corner mounting swivel bracket (see Fig. 5).

**BR-3** - ceiling mounting bracket (see Fig. 5).

**Attention!** With swivel brackets in use, the effective detection range may differ from that indicated in Table 2.

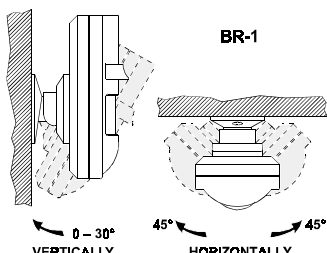

Fig. 4. Hunter with BR-1

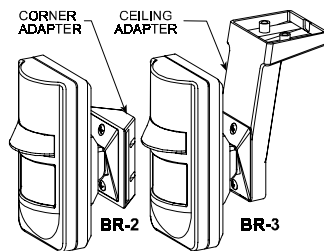

Fig. 5. Hunter with BR-2 / BR-3

## 3.5 Wiring

### A. Terminal Assignments

#### N.C. relay output:

The normally closed alarm relay contacts open upon detection of motion (alarm) or during a power failure.

**TAMP (tamper output):** The TAMP (tamper) contacts, which are normally closed, open when the unit's front cover is removed.

**TRB (trouble) Relay:** The normally closed trouble relay contacts open when masking is sensed or when trouble is detected by the unit's self test circuitry.

**T (TEST) input:** Used to remotely switch the detector into the walk-test mode and back to normal, by applying +12 VDC or 0 VDC to this terminal (see SW-4 in Para. 3.6).

**E.O.L. terminals:** The two "floating" E.O.L. terminals serve only as connection points for E.O.L. (end-of-line) resistors.

### B. Wiring Procedure

Refer to Figure 6 and use #22 AWG or larger conductors to wire the detector as follows:

- (1) Connect one N.C. output terminals of the detector to a burglar zone terminals of the alarm control panel.
- (2) Connect the detector's TAMP terminals across the terminals of a 24-hour zone of the alarm control panel.
- Note:** If the control panel is set for E.O.L. and you are wiring the most distant detector in the loop, use the closest E.O.L. terminal to connect the required E.O.L. resistor in series with the loop.
- (3) Connect the detector's TRB relay terminals across the terminals of a 24-hour trouble zone of the control panel.
- (4) Connect a single wire between the detector's T terminal and the walk-test control voltage source (see Para. 3.6 for TEST input polarity).

- (5) Connect the 12 V (+) and (-) terminals to a 9 - 16 VDC power source and check for correct polarity. The power supply must have at least 4 hours of battery backup. The standby current consumption of each detector unit is about 17 mA.

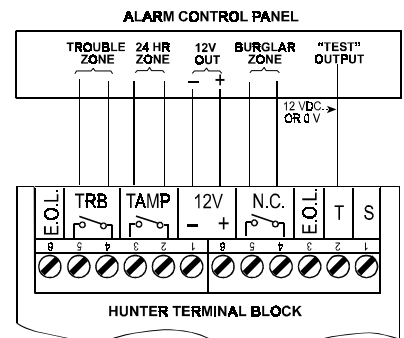

Figure 6. Terminal Block Wiring

## 3.6 The Function Switches

### A. Switch Tasks

The HUNTER is equipped with a 4-position DIP switch function selector (see Fig. 3).

Table 1. Setting the Function Selector

Switch	Function	Pos.	Selected Option
SW-1	Motion event Counter	ON	2 motion events to alarm
		OFF	1 motion event to alarm
SW-2	LED control	ON	Both LEDs are enabled
		OFF	Both LEDs are disabled
SW-3	Reset after trouble	-	Resets the unit when switched from OFF to ON or ON to OFF
SW-4	Selects the TEST ("T") input signal polarity	ON	0 V disables walk test
		OFF	+12 VDC enables walk test*
		ON	+12 VDC disables walk test*
		OFF	0 V enables walk test*

\* +12 VDC or open circuit.

**Note:** OFF is not effective in the walk test mode and during the power-up adaptation period.

## B. Setting the Switches

Set the function switches as desired prior to applying power. **The ON position is indicated on the switch body.**

**SWITCH SW-1:** If you set this switch to OFF (1 motion event), the detector's sensitivity will be increased, and if you set this switch set to ON (2 motion events), you will get the highest immunity against false alarms.

**SWITCH SW-2:** You may enable or disable the LED walk-test indicators. However, even if disabled, they will be automatically enabled when the detector is switched to the test mode.

### SWITCH SW-3

Resetting after trouble - it makes no difference whether the lever is switched from OFF to ON or vice versa.

**SWITCH SW-4:** Set this switch in accordance with the control panel's TEST output. If there is no such output, simply wire the control panel's 0 VDC (ground) to the detector's "T" terminal through a TEST switch installed at a convenient location.

Set SW-4 to OFF if you do not intend to use the T input.

## 3.7 Vertical Pattern Adjustment

To adjust the vertical pattern, loosen the vertical adjustment screw slightly and slide the electronic module up or down to the desired angle. Adjust the scale according to Table 2 for the desired mounting height and coverage range. Once the module is aligned correctly, tighten the screw firmly.

Table 2. Vertical Adjustment Chart

Mounting Height ft ↓	m	Coverage Range									
		7	10	13	17	20	23	26	30	40	50
3	1	0°	0°	0°	0°	0°	0°	0°	0°	0°	0°
4	1.2	-8°	-6°	-5°	-4°	-3°	-2°	-2°	-2°	-1°	-1°
5	1.5	-	-12°	-9°	-7°	-6°	-5°	-5°	-4°	-3°	-2°
6	1.8	-	-	-	-11°	-9°	-8°	-7°	-6°	-5°	-4°
7	2	-	-	-	-	-12°	-10°	-9°	-8°	-6°	-5°
8	2.5	-	-	-	-	-	-	-11°	-10°	-7°	-6°
10	3	-	-	-	-	-	-	-	-	-10°	-9°
12	3.6	-	-	-	-	-	-	-	-	-12°	-10°

**Example:** if you require coverage range of 40 ft (12 m) and wish to install the sensor at a height of 6 ft (1.8 m) from the ground, set the Vertical Adjustment Scale to -5°.

## 3.8 Horizontal Pattern Adjustment

The coverage pattern may be adjusted  $\pm 7.5^\circ$  by shifting the lens off its centered position:

- Remove the lens holder as shown in Figure 7.
- Shift the lens in the desired direction (right or left).
- Hold the lens in position and re-insert the lens holder - bottom end first. Next, push the top end against the front cover until the lens holder snaps into place.

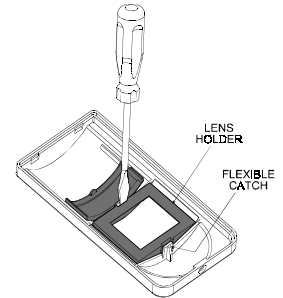

Figure 7. Releasing the Lens

# 4. OPERATION AND TESTING

## 4.1 Output Circuit Behavior

### A. Alarm Relay

When an alarm occurs, the alarm relay contacts open for 2-3 seconds.

### B. TRB Relay

The TRB relay drops out (its contacts open) whenever masking is detected, or upon detection of an internal malfunction by automatic self test routine. The relay pulls in as soon as the cause for trouble is removed.

## 4.2 LED Display

Two LEDs, red and green, convey status information by various signaling combinations, as detailed in Table 3 below. However, the following rules must be taken into account:

- The LED indicators may be enabled by setting DIP switch SW-2 to ON or applying "test enable" voltage to the "T" terminal. **While being enabled by one, the LEDs can not be disabled by the other.**
- Even if the LEDs are disabled, they will still function throughout the 2-minute power-up adaptation period and as trouble indicators.

Table 3. LED Displays

State of RED LED	State of GREEN LED	Interpretation
Flashing	Flashing	Adaptation period (about 2 minutes) upon power up.
OFF	OFF	Ready to detect. There are presently no alarm/trouble events.
ON (2-3 s)	N/A	Motion is being detected.
N/A	Flashing	Masking or internal failure state.

## 4.3 Resetting after Trouble

Flashing of the green LED indicates that masking or internal circuit trouble are being sensed. While the green LED flashes, the TRB relay contacts are open.

To determine the cause for trouble, check for masking:

- Foreign material may be glued to the lens or sprayed on it.
- An object may have been placed less than 0.5 m (1.5 ft) away from the detector.
- An object situated in the detector's field of view less than 0.5 m (1.5 ft) from the detector has been re-located (the detector "considers" this change in its surroundings as a masking event).

**Note:** Erratic behavior of the detector may result from partial masking - check the lens very carefully.

Remove masking if found. Then remove the cover, change the position of DIP switch SW-3 (from OFF to ON or vice versa), mount the cover quickly in place and get away from the detector.

**IMPORTANT!** Changing the position of SW-3 resets the detector and causes it to re-adapt to its current surroundings for 2-minutes. **Stay at least 0.5 m (1.5 ft) away from the detector, so as not to disrupt this process.** The green and red LED will flash alternately until the 2 minute period is up. If they continue to flash, check again for masking.

Reset is also possible without removing the cover - apply the "test enable" voltage to the "T" terminal (see Para. 3.6) and conduct a short walk test, causing the detector to alarm at least 3 times.

After reset, the detector should function normally - the green LED should not flash and the TRB relay contacts should close. If this is not so, and masking has been ruled out, the trouble indication is probably due to internal circuit trouble. The only remedy for this is replacing the detector unit with a new one.

## 4.4 Testing procedure

- Set SW-2 to ON, or leave it OFF but apply the "test enable" voltage to the "T" terminal. Remount the detector's cover.
- Power up the system. The red and green LEDs will flash alternately, indicating that the detector is adapting itself to its present surroundings. **Stay at least 0.5 m (1.5 ft) away from the detector, until the 2-minute startup period ends** (until the LEDs stop flashing alternately).

- C. Enter the detector's field of view and walk test the entire coverage area, while observing the red LED. The LED will light for 2-3 seconds each time your motion is detected.
- D. Tape a piece of cardboard to the detector's front to deliberately mask the lens. After 30 seconds, the green LED should start flashing, and the trouble zone of the control panel should go into alarm (the TRB relay drops out).
- E. Remove the masking from the detector's front. The green LED should extinguish (after a few seconds).
- F. Apply the desired voltage to the "T" terminal, or set SW-2 as desired to enable/disable the LEDs. The detector is ready for use.

## WARRANTY

Visonic Ltd. and/or its subsidiaries and its affiliates ("the Manufacturer") warrants its products hereinafter referred to as "the Product" or "Products" to be in conformance with its own plans and specifications and to be free of defects in materials and workmanship under normal use and service for a period of twelve months from the date of shipment by the Manufacturer. The Manufacturer's obligations shall be limited within the warranty period, at its option, to repair or replace the product or any part thereof. The Manufacturer shall not be responsible for dismantling and/or reinstallation charges. To exercise the warranty the product must be returned to the Manufacturer freight prepaid and insured.

**This warranty does not apply in the following cases:** improper installation, misuse, failure to follow installation and operating instructions, alteration, abuse, accident or tampering, and repair by anyone other than the Manufacturer.

This warranty is exclusive and expressly in lieu of all other warranties, obligations or liabilities, whether written, oral, express or implied, including any warranty of merchantability or fitness for a particular purpose, or otherwise. In no case shall the Manufacturer be liable to anyone for any consequential or incidental damages for breach of this warranty or any other warranties whatsoever, as aforesaid.

This warranty shall not be modified, varied or extended, and the Manufacturer does not authorize any person to act on its behalf in the modification, variation or extension of this warranty. This warranty shall apply to the Product only. All products, accessories or attachments of others used in conjunction with the Product, including batteries, shall be covered solely by their own warranty, if any. The Manufacturer shall not be liable for any damage or loss whatsoever, whether directly, indirectly, incidentally, consequentially or otherwise, caused by the malfunction of the Product due to products, accessories, or attachments of others, including batteries, used in conjunction with the Products.

The Manufacturer does not represent that its Product may not be compromised and/or circumvented, or that the Product will prevent any death, personal and/or bodily injury and/or damage to property resulting from burglary, robbery, fire or otherwise, or that the Product will in all cases provide adequate warning or protection. User understands that a properly installed and maintained alarm may only reduce the risk of events such as burglary, robbery, and fire without warning, but it is not insurance or a guarantee that such will not occur or that there will be no death, personal damage and/or damage to property as a result.

**The Manufacturer shall have no liability for any death, personal and/or bodily injury and/or damage to property or other loss whether direct, indirect, incidental, consequential or otherwise, based on a claim that the Product failed to function.** However, if the Manufacturer is held liable, whether directly or indirectly, for any loss or damage arising under this limited warranty or otherwise, regardless of cause or origin, the Manufacturer's maximum liability shall not in any case exceed the purchase price of the Product, which shall be fixed as liquidated damages and not as a penalty, and shall be the complete and exclusive remedy against the Manufacturer.

**Warning:** The user should follow the installation and operation instructions and among other things test the Product and the whole system at least once a week. For various reasons, including, but not limited to, changes in environmental conditions, electric or electronic disruptions and tampering, the Product may not perform as expected. The user is advised to take all necessary precautions for his/her safety and the protection of his/her property.

6/91



VISONIC LTD. (ISRAEL): P.O.B 22020 TEL-AVIV 61220 ISRAEL. PHONE: (972-3) 645-6789, FAX: (972-3) 645-6788  
 VISONIC INC. (U.S.A.): 10 NORTHWOOD DRIVE, BLOOMFIELD CT. 06002-1911. PHONE: (860) 243-0833, (800) 223-0020 FAX: (860) 242-8094  
 VISONIC LTD. (UK): FRASER ROAD, PRIORY BUSINESS PARK, BEDFORD MK44 3WH. PHONE: (0870) 7300800 FAX: (0870) 7300801  
 INTERNET: www.visonic.com

©VISONIC LTD. 2002 HUNTER D-1220-0 NEW: DE1220- (REV. 5, 5/02)



MADE IN  
ISRAEL